



Inductive sensor

NMB1,5-8GM35-E2-FE-150MM-V1

- Stainless steel sensing face
- Sensing range 1.5 mm
- 3-wire DC



Dimensions

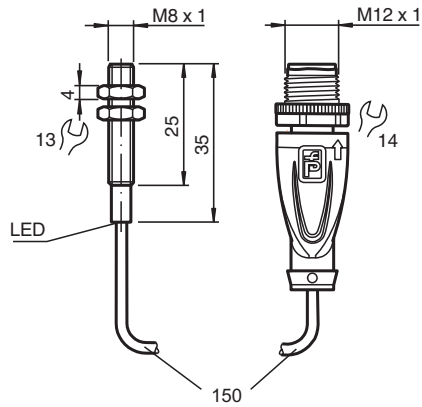

Technical Data

General specifications

Switching function		Normally open (NO)
Output type		PNP
Rated operating distance	s_n	1.5 mm
Installation		flush
Output polarity		DC
Assured operating distance	s_a	0 ... 1.215 mm

Release date: 2023-06-13 Date of issue: 2023-06-13 Filename: 904816_eng.pdf

Refer to "General Notes Relating to Pepperl+Fuchs Product Information".

Pepperl+Fuchs Group
www.pepperl-fuchs.com

USA: +1 330 486 0001
fa-info@us.pepperl-fuchs.com

Germany: +49 621 776 1111
fa-info@de.pepperl-fuchs.com

Singapore: +65 6779 9091
fa-info@sg.pepperl-fuchs.com

PF PEPPERL+FUCHS

Technical Data

Actuating element	Ferrous targets	
Reduction factor r_{Al}		0
Reduction factor r_{Cu}		0
Reduction factor r_{304}		0.4 - 0.7
Reduction factor r_{316}		1
Reduction factor r_{Brass}		0
Output type	3-wire	
Nominal ratings		
Operating voltage	U_B	10 ... 30 V DC
Switching frequency	f	80 Hz
Hysteresis	H	5 ... 15 typ. 10 %
Reverse polarity protection		yes
Short-circuit protection		yes
Voltage drop	U_d	≤ 2 V
Operating current	I_L	≤ 100 mA
Current consumption		≤ 10 mA
Off-state current	I_r	≤ 10 μ A
Indicators/operating means		
Operation indicator	LED red: Output	
Standard conformity		
Standards	EN 60947-5-2:2007 IEC 60947-5-2:2007	
Approvals and certificates		
UL approval	cULus Listed, General Purpose	
CSA approval	cCSAus Listed, General Purpose	
CCC approval	CCC approval / marking not required for products rated ≤ 36 V	
Ambient conditions		
Ambient temperature	-25 ... 75 °C (-13 ... 167 °F)	
Mechanical specifications		
Connection type	Cable connector M12 x 1 , 3-pin with PUR cable 150 mm	
Core cross section	0.14 mm ²	
Housing material	Stainless steel 1.4305 / AISI 303	
Sensing face	Stainless steel 1.4305 / AISI 303	
Degree of protection	IP67	

Connection

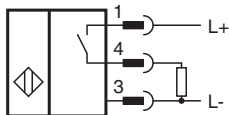



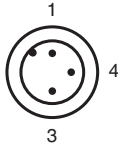

Connection Assignment



Wire colors in accordance with EN 60947-5-2

1	BN	(brown)
3	BU	(blue)
4	BK	(black)

Accessories

	V1-G-2M-PUR	Female cordset single-ended M12 straight A-coded, 4-pin, PUR cable grey
	V1-W-2M-PUR	Female cordset single-ended M12 angled A-coded, 4-pin, PUR cable grey
	MH V1-SCREWDRIVER	Torque screwdriver (0.6 Nm)
	MH V1-BIT M12	plug-in cap M12

Release date: 2023-06-13 Date of issue: 2023-06-13 Filename: 904816_eng.pdf